



Intelligent PTZ keyboard controller

USERS MANUAL

Copyright(c)2012(V2.1)



Prompt

No unit or individual is allowed to the product all or part of the copy, regeneration or translated into other machine readable form of electronic media;

This manual might be not accurate technically or contains some minor typo errors. The contents in this manual about production description and program might be updated on an un-periodical.

Cautions

The LCD is fragile, no crush or long-exposed under strong light.

Joystick is fragile, please make sure product is packed with original packing material when you send it back for reparation.

The keyboard controller should be work in specified range of temperature and humidity. Please follow the connecting method defined in this manual.

Keyboard Controller Parameters

Item	Parameters
Power Supply	DC12V 1A \pm 10%
Temperature	-10°C ~ 55°C
Humidity	<90% RH (No cream node)
Communication	RS485 Half-duplex
Baud Rate	2400bps、4800bps、9600bps、19200bps、38400bps
Screen	128*32 LCD screen
Package Size	180 (L)X165 (W)X90 (H)mm

List Of Items

Name	Quantity	Units	Remarks
Power adapter	1	pcs	input: 100-240VAC 50/60Hz, output: DC 12V
《Users Manual》	1	pcs	N/A
QC pass	1	pcs	N/A



KEYBOARD FRONT BOARD INTRODUCTION

1.1 Function Keys On Front Panel

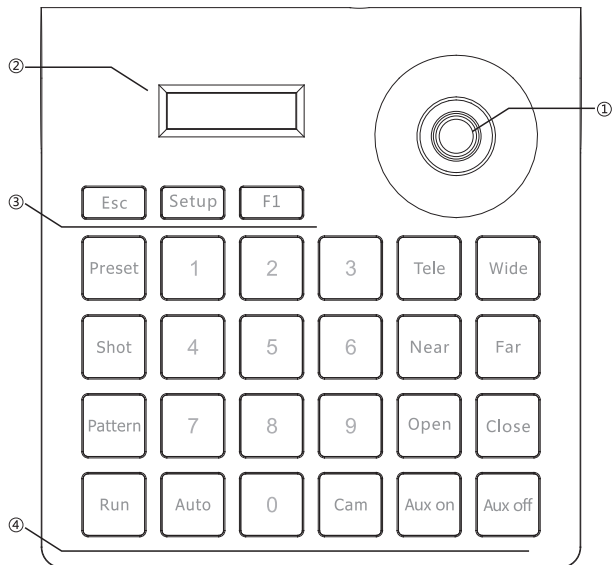

- ①: Joystick
- ②: LCD screen
- ③: Function keys
- ④: Speed dome Setup and recall keys



- [Esc]** exit key : exit and back to previous menu;
- [Setup]** setup key : press and hold for 3s to setup keyboard's parameter.
- [F1]** adjust the control speed, it has 4 level : 1、 2、 3、 4 ;
- [Preset]** preset special status of ptz(including direction and zoom times) : this key should be used together with number key;
- [Shot]** recall special status of ptz(including direction and zoom times) : this key should be used together with number key;
- [Pattern]** start/stop pattern record: press for 3 seconds to start pattern record, after all operation, press this key again to stop pattern record, this key should be used together with number key;
- [Run]** recall the stored pattern, this key should be used together with number key;
- [0] ~ [9]** number key : 0、 1、 2、 3、 4、 5、 6、 7、 8、 9
- [Auto]** control ptz rotate in horizontal direction automatically or clear input number: when user input some numbers, press this key can delete the numbers, else it will control ptz rotate in horizontal direction automatically;
- [Cam]** address selection key : select ptz address; this key should be used together with number key;
- [Tele]** zoom in : zoom in the object, enlarge the object size;
- [Wide]** zoom out : zoom out the object, reduce the object size;
- [Open]** iris + : enlarge iris;
- [Close]** iris - : reduce iris;
- [Far]** focus+ : adjust the lens focus on distant object;
- [Near]** focus- : adjust the lens focus on near object;
- [Aux on]** aux on : turn on ptz's aux. function, this key should be used together with number key; directly press this key without keying in any number, the controlled ptz ID will add 1.



[Aux off] aux off : turn off ptz's aux. function, this key should be used together with number key; directly press this key without keying in any number, the controlled ptz ID will take away 1.

[press joystick] press and hold for 3s to recall number 95 preset, normally it will be opening the menu of ptz.





1.2 LCD Screen

Press each function key, LCD screen will show relevant information, press And hold the key, relevant information will show while release it will disappear. When there is no operation over 30s, it will get into power-save mode(its backlight will be turned off), it will show standby image, details as bellow:





```
PTZ ADDR: XXX
P:PELCO B.2400
```

1.3 Joystick Control

When control speed dome and mounting plate:

Operating	Output Control	Operating	Output Control	Operating	Output Control	Operating	Output Control
	Upward		Downward		Left		Right

When control Setup of keyboard controller:

Operating	Output Control	Operating	Output Control	Operating	Output Control	Operating	Output Control
	Menu turned up		Menu turned down		Parameter of the left		Parameter of the right



KEYBOARD CONTROLLER OPERATIONS

2.1 Introduction To single-press Keys And Combined Keys

2.1.1 Single-press key: When single key is pressed, the corresponding PTZ will respond.

Single-press keys include: **【Near】** , **【Far】** , **【Tele】** , **【Wide】** , **【Open】** , **【Close】** , **【Auto】** , **【F1】** , **【Run】** , **【Esc】** , joystick.

2.1.2 Combined key operations mean 2 or more keys, or key and joystick are pressed, the corresponding PTZ will respond.

The operations include: **【Preset】** , **【Pattern】** , **【Shot】** , **【Cam】** , **【Setup】** .

2.2 Detailed introduction to combined keys

2.2.1 Select PTZ ID:

select speed dome or decoder whose ID is 28: press **【2】** 、 **【8】** 、 **【Cam】** in turn, LCD will display as below (corresponding protocol and baud rate will also be showed).

```
PTZ ADDR: 028 ④  
P:PELCO D  B:2400
```

2.2.2 set and recall pattern:

Set pattern : select PTZ addr., press **【pattern】** key and hold for more than 3s, LCD will display:

```
PTZ ADDR: 028 ④  
PATTERN RECORD
```

Operate joystick to control PTZ moving to relevant position, adjust zoom time. After setup, press **【pattern】** key to finish, LCD will display:

```
PTZ ADDR: 028 ④  
PATTERN STOP
```



Recall pattern : press **【Run】** key,PTZ will run in the certain route which recorded in relevant pattern;

Press any single-press key will stop pattern scan and back to normal status;

Note: This keyboard supports setting one pattern at present.

2.2.3 set and recall preset point:

Set preset point 1: key in **【1】** , press **【Preset】** .

Recall preset point 2: key in **【2】** , press **【Shot】** .

2.2.4 Turn on/Turn off aux function

Turn on: need to open number 1 aux. function, press **【1】** , press **【AUX on】** .

Turn off: need to close number 1 aux. function, press **【1】** , press **【AUX off】** .



PARAMETER SETUP AND INQUIRY

3.1 Parameter Setup And Inquiry

e.g.: change the protocol of PTZ 28 to PelcoP, baud rate to 9600.

in normal status, press and hold **【setup】** key for more than 3s, LCD will display:

```
PTZ ADDR: 028 ④  
PASSWORD: ----
```

key in password (default: 8888) , press joystick, LCD will display:

```
*PTZ SETUP  
SYSTEM SETUP
```

Press joystick, LCD will display:

```
*PTZ ADDR: 001  
P:PELCOD
```

Move the joystick toward left/right to select PTZ 28, LCD will display:

```
*PTZ ADDR: 028  
P:PELCOD
```

Press joystick, LCD will display:

```
PTZ ADDR: 028  
*P:PELCOD
```

Move the joystick toward right, LCD will display:

```
PTZ ADDR: 028  
*P: PELCOP
```

Press joystick, finish protocol setup and switch to baud rate setup, LCD will display:

```
PTZ ADDR: 028  
*B: 2400
```

Move the joystick toward right till LCD display:

```
PTZ ADDR: 028  
*B: 9600
```

Press joystick, finish setup and back to select PTZ ID menu, repeat above steps, you can set other PTZ parameter.



after finishing all setup, press **[ESC]** key to quit setup.

Note:

If you want to set all PTZ's protocol and baud rate as same, when you select PTZ ID in setup menu, please select 0-255, details as below:

```
*PTZ ADDR: 0-255
P:PELCO0
```

Follow above steps, all PTZ's protocol and baud rate will be set as same.

3.2 System Parameter Setup

System parameter including : language、password、key-press volumn、key backlight、default factory setup。 The following example is "default factory setup"operation steps:

In normal status, press and hold **[setup]** key for more than 3s, LCD will Display:

```
PTZ ADDR: 028 ④
PASSWORD: ----
```

Key in password (default password: 8888) , press joystick, LCD will display:

```
*PTZ SETUP
SYSTEM SETUP
```

Move the joystick toward down, LCD will display:

```
PTZ SETUP
*SYSTEM SETUP
```

Press joystick, LCD will display:

```
*LANGUAGE
PASSWORD SETUP
```

Move joystick till LCD display:

```
*DEFAULT FACTORY
SETUP
```

Move joystick toward right, LCD will display:

```
*DEFAULT FACTORY
SETUP ?
```



Press joystick, the buzzer will give out long time sound, the question mark“?” in screen will disappear, denote setup finished, press 【ESC】 key to quit setup.

3.3 Parameter Setup Framework:

*PTZ setup	*PTZ addr : xxx	protocol	Pelco D、PelcoP HIK、DAHUA
	*PTZ addr : 0-254 (all PTZ parameter will be set as same)	Baud rate	2400、4800、9600、 19200、38400
*system setup	*Language	Chinese、English	Move joystick to select
	*password setup	Old password :	4 digit number
		New password :	4 digit number
		Enter again :	4 digit number
	Key-press sound volumn	close、low、 mid、high	Move joystick to select
	Key backlight (optional)	close、30S、60S、 120S、open	Move joystick to select
Default factory setup	N/A	Move and press joystick to select	

TYPICAL CONNECTING DIAGRAM

4. Typical connecting diagram

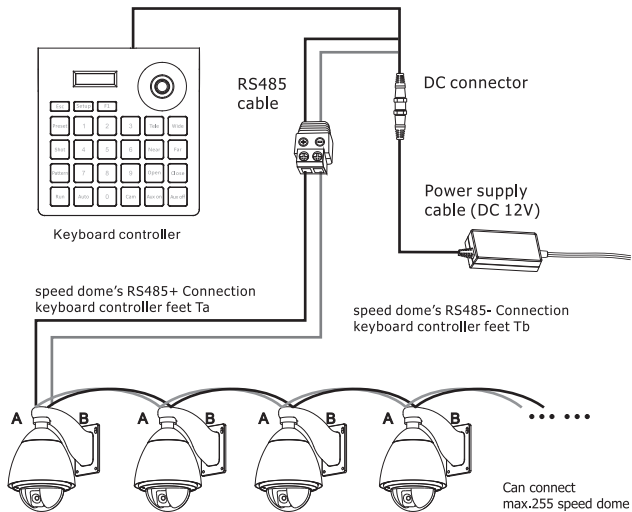



FAQ

Symptom	Analysis	Methods
keyboard controller cannot control the speed dome.	1 : Check the hardware: RS485.	Step 1: RS485 A and B is reversed. Step 2: Check RS485 cable continuity is OK or not.
	2 : Check the software settings: keyboard controller and speed dome address, protocol, baud rate.	Step 1: check the current protocol and baud rate is correct or not. Step 2: Restore the settings to default setting and reset.
Some speed domes can be controlled but some not.	1 : Check hardware	Check the continuity of each branch cable
	2 : Check software settings	Check the protocol and baud rate of each address code.
	3: Might be the problem of star-type connection	Step 1: connect RS485 to a 120Ω resistor at far end. Step 2: Install RS485 distributor between the speed dome and keyboard controller.
many speed domes respond simultaneously when operate the keyboard controller	Check the ID of speed domes	Check whether those speed dome that respond simultaneously have the same address code or not, Set different address.
No key tone.	Turn on key tone in system settings.	

|| information are checked carefully to obtain accuracy.If there are misprints, try to be understanding.

■ 006.08.09-40010 ■